



## *MERLIN™ Surgical System*

Operator's Manual

for the

Condenser Lens Assembly (Manual only)

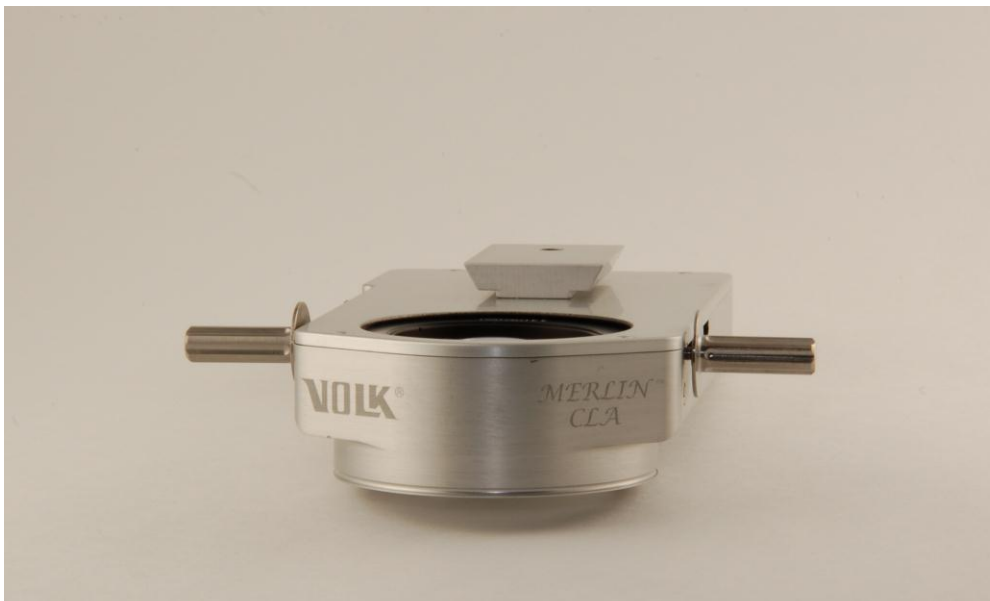

Volk Optical Inc.  
7893 Enterprise Drive  
Mentor, OH 44060

**Introduction**

Volk Optical Inc., the leader in aspheric optics is pleased to deliver the MERLIN Surgical System- Volk Optical's next generation non-contact retinal viewing system providing precision maneuvering and control capabilities for non-contact surgical lenses.

*MERLIN*

The MERLIN CLA (Condenser Lens Assembly) Surgical System is compatible with all leading surgical microscopes, and provides an elegant maneuverability solution for your surgical lens.

It is designed to ensure your lens is positioned precisely where you require, with easy manipulation, obtaining the best views for your surgical procedures.

We have designed the system to be used with non-contact lens options to suit your personal preferences. Our non-contact lenses are available in a variety of technical specifications; from the widest non-contact field of view available to mid-field magnification as well as a design for deep access in difficult anatomies. See our catalog for all the lens options available to you.

## Table of Contents

Function and Intended Application .....	4
Warnings, Markings & Symbols .....	5
Safety Instructions .....	6
Technical Specifications .....	7
MERLIN CLA .....	7
MERLIN Components and Equipment List .....	8
Unpacking Your New System .....	9
Installation .....	11
Installation .....	12
Customize the MERLIN to Your Microscope .....	13
Operating – MERLIN CLA .....	14
Acquiring the Retinal Image – MERLIN CLA .....	15
Dismantling the MERLIN CLA .....	16
Cleaning and Sterilization .....	17
Cleaning and Sterilization .....	17
MANUAL CLEANING INSTRUCTIONS FOR LENS POSITIONING UNIT, LENSES, REMOVABLE HANDLE and LENSES (in sterilization tray as applicable) .....	17
Inspection / Function Check .....	18
Packaging .....	18
STERILIZATION INSTRUCTIONS FOR LENS POSITIONING UNIT, LENSES, REMOVABLE HANDLE and LENSES (in sterilization tray as applicable) .....	18
CLEANING THE MERLIN CLA HOUSING AND CONDENSER LENS .....	18
Troubleshooting .....	19
Storage & Transport .....	20
Service and Repair .....	21
Inspection / Preventative Maintenance .....	21
Regulatory Information .....	24
Appendix A – Microscopes and Adapters .....	25

## Function and Intended Application

The Volk MERLIN Surgical System fits onto a surgical microscope and is a modular system that allows the surgeon to dynamically adjust the position and orientation of non-contact indirect (inverting) ophthalmic surgical lenses in relation to a patient's eye. MERLIN provides firm mechanical support, keeping the lens aligned – freeing the surgeon or nurse-assistant from supporting the ophthalmic lens during the course of the surgical treatment.



The MERLIN Surgical System hard mounts directly below the objective of the surgical microscope. The system consists of two major sub-assemblies, the Condenser Lens Assembly (CLA) and the Fine Focus Lens Positioning Unit (referred to as LPU in this manual).

The CLA is mounted and positioned for precise lens alignment to the surgical microscope optical axis. It allows 360° rotation of the attached LPU and lens about the optical axis. The LPU consists of a connection assembly that attaches to the CLA, a pair of vertical shafts, turn knobs for fine focus control and lens holder. The LPU can be pivoted completely out of the surgical field when the non-contact lens is not in use.

An ophthalmic lens is mounted to the lower end of the LPU. The ophthalmic lens can be dynamically positioned above the patient's eye. The LPU mates to the mount using a quick-connect assembly. It allows the LPU to be easily connected and removed from the CLA. The LPU is compatible with steam sterilization using an autoclave. Its interface has been engineered so that it can be easily processed for autoclaving after each and every surgery. Please register your product on line at [www.volk.com](http://www.volk.com) or complete and mail the enclosed registration card. Registering your purchase will safeguard your investment by:

- ◆ ensuring you receive updates with product information, maintenance tips or industry news
- ◆ ensuring Volk Optical can contact your distributor if servicing is needed on your product
- ◆ enabling Volk Optical to improve product design based on your input and needs

## Warnings, Markings & Symbols

Symbol	Description
	ATTENTION: Refer to the manual. The user is advised of important operating and maintenance instructions.
	Follow the cleaning and sterilization instructions detailed within this manual
	Service or repair is to be performed by qualified, authorized personnel. Return to Volk for servicing. Do not attempt to repair this Assembly.
	Disassembly of this unit beyond the instructions in this manual will void the warranty.
	Do not operate or leave this Assembly in any environment that may exceed +10° C to 40°C; relative humidity of 30% to 75%; and an atmospheric pressure range of 700 hPa to 1060 hPa.
	The CE mark on this device indicates that it has been tested and conforms to the provisions noted within the 93/42/EEC Medical Device Directive.

<b>Disposal</b>
The MERLIN CLA contains no known hazardous chemicals or components. It should be disposed of properly.

## Safety Instructions

Before installing or using this equipment familiarize yourself with the operating instructions and all safety features.

If you cannot understand these instructions, including warnings and cautions, contact Volk personnel before installation or use.

Follow all the instructions for setup, usage, sterilization and disassembly. If you have any questions, please contact a Volk representative.

Check all parts for damage and test before use. The MERLIN Surgical System must be in proper working order; do not use if there is any damage or if the Assembly is in need of repair.

The MERLIN Surgical System must be used only with the original accessories and parts supplied or specified by Volk Optical otherwise the warranty is void.

The MERLIN Surgical System may only be used for its intended use in the surgical specialties by educated and qualified personnel. The surgeon shall be responsible for the proper selection for each application, for obtaining the appropriate training, knowledge and experience.

Volk Optical cannot be responsible for any liability for damages caused by inappropriate application and use or by inappropriate cleaning and sterilization and care of the system.

Never connect this instrument with any other product that is not specifically designed to be used with the MERLIN system.

Do not operate the MERLIN Surgical System outside of the stated environmental operating conditions.

---

## Technical Specifications

### MERLIN CLA

FDA Classification	Class 1
Degree of Protection against the Presence of Flammable Anesthetic Mixtures	Ordinary equipment, not for use in a flammable atmosphere
Interfaces	Hard mounts to common surgical microscopes. Volk MERLIN LPU
Mount Size	162mm x 86mm x 32mm (6.3" x 3.4" x 1.3")
Weight	411 g
Storage/Transport Conditions	Temperature: +10° C to +40°C
Operating Conditions	Temperature: +10° C to +40°C
Mode of Operation	Continuous Operation
Sterility	Components of this system which are sterilizable are shipped in a non-sterile condition. Sterilize before use.
Materials	All metal components are surgical grade materials. This product is latex free.

## MERLIN Components and Equipment List



### Condensing Lens Assembly (CLA)

Hard mounts below Microscope objective. Provides attachment assembly for Lens Positioning Unit with 360° rotation about optical axis.



### Lens Positioning Unit (LPU)

Holds the lens over the patient with full-scale adjustment. LPUs are sized specifically for the microscope objective lens focal lengths of 175mm or 200mm.



### Lenses

The optical viewing element for viewing the eye anatomy.



## Unpacking Your New System

You are strongly urged to keep all original shipping materials and containers in the event of future storage or transportation.

All components and parts should be handled with care.

*Verify all components for shipping damage*

Remove and check that the following components are present and free from any damage:

### MERLIN Lenses and sterilization case

- Lens mini sterilization case should be opened, shipping material removed and all lenses checked for shipping damage.
- Lens elements (quantity and type will vary based on your order) – Check to make sure the lenses are not cracked, loose or dislodged from their housings.



### MERLIN Condenser Lens Assembly

- Remove from case and check for damage.



### MERLIN Lens Positioning Unit

- Remove from case and check for damage.

**Note – Use only the focus adjustment knobs to adjust the height of the lens. Do not push or pull directly on the assembly rod.**



#### MERLIN Microscope Adapter Plates

- All plates have a code, which relates to your microscope. See appendix A to identify the correct code and mounting instructions.

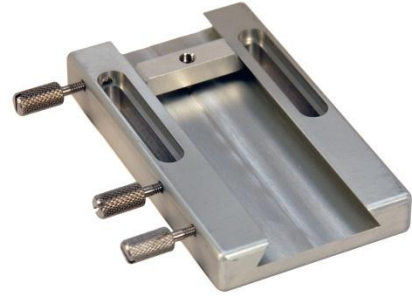
**NOTE:**

The system should be assembled and tested for correct functionality prior to first use.

## Installation

- Turn off the electrical power to the microscope and attached microscope accessories.
- Identify the correct adapter for your microscope (see appendix A).
- Attach the selected adapter plate to the microscope with the enclosed socket head cap screws using an Allen key or hex-wrench (not included). The screws will fit into the existing mount holes on the microscope, through the bottom of the adapter plate
- Mount the MERLIN CLA to your microscope by aligning the unit into the plate groove in the adapter plate.
- Adjust and fix the small dovetail plate against the MERLIN CLA mounting dovetail plate.
  - The small dovetail plate serves as a hard-stop for consistent front-to-back alignment of the device relative to the scope objective lens.
- Hand-tighten the screws on the side of the adapter plate.
- To attach the LPU:
  - Press and hold the quick disconnect button on the LPU.
  - Mate the LPU locating pins to the matching holes in the rotational ring of the CLA.
  - Release the quick disconnect button on the LPU.
  - Gently pull on the LPU to confirm that it is properly and securely mounted in the rotational ring of the CLA.
- To attach a lens
  - Hold the LPU at the lens mounting assembly.
  - Hold the lens with your other hand and push in until the lens is securely in place. You will hear a click when the lens is fully seated.
  - After inserting the lens, if needed rotate the lens to its centered position in the LPU. You will feel the locating detent click when the lens is properly centered.



See Appendix A



## Installation

- Occasionally, the MERLIN CLA cannot be affixed to the mounted adapter plate due to interference with another attached piece of equipment or a feature of the scope itself.
- If needed, the Spacer Kit may be used to extend the vertical position of the MERLIN CLA down relative to the adapter plate and scope.
  - Volk item number 11425 – see the table in Appendix A.
- The Spacer Kit is comprised of 0.250" (~6mm) spacers and bolts of various lengths.

### **Installing Spacers on the MERLIN CLA**

- Remove the installed bolt that affixes the dovetail plate to the MERLIN CLA housing.
- Spacers will be installed **between** the dovetail and the MERLIN CLA housing.
- Select the **minimum number** of spacers required to:
  - extend the MERLIN CLA down to a point where it will affix to the adapter plate without any interference **and**
  - is **as close to the objective lens as possible** (see NOTE below).
- Re-attach the dovetail and spacers to the MERLIN CLA housing with the appropriate length bolt for the number of spacers chosen.

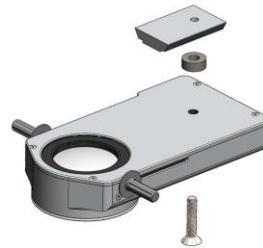
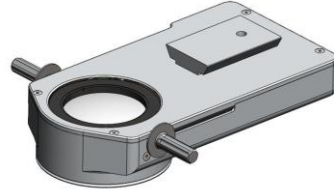

#### **NOTE:**

**Use of spacers may affect the focal position of the LPU and lens.**

**If added spacers extend the MERLIN CLA further down and away from the scope objective lens then that distance must be compensated by adjusting the LPU and non-contact lens up in order to achieve a focused image.**

**If too many spacers are added then the distance may extend beyond the LPU's adjustment range to compensate and a focused image may not be possible.**

## Customize the MERLIN to Your Microscope

- Look at a model eye through the microscope and the LPU.
- A suggested starting point is with the lens about 3 – 5 mm from the eye and the Lens Positioning shaft at mid-point of its adjustment range.
- The LPU shaft is designed to adjust up or down using the adjustment knobs.
- The LPUs are specifically designed for specific objective lens focus lengths (175mm or 200mm).
- The shaft will move about 30mm to properly focus the non-contact lens on the retinal image.
- Rotate the fine focus adjustment knob until an image is seen.



**Note – Use only the focus adjustment knobs to adjust the height of the lens. Do not push or pull directly on the assembly rod.**

## Operating – MERLIN CLA

**NOTE: The LPU and lenses must be cleaned and sterilized before they are used in any surgical procedure. See cleaning and sterilization instructions.**

- Attach the MERLIN mount to your microscope per the installation instructions in the **Installation** section.
  - Rotate the LPU to its retracted position out from under the microscope objective lens.
- 
- The LPU's design allows for 360° rotation about the optical axis:
    - with the LPU deployed (LPU is “lens down” in vertical position with lens under objective).
    - with the LPU retracted (LPU is “lens up” in horizontal position).
  - The LPU pivot block includes a detent that fixes the LPU in the “up” position when retracted.
    - The LPU pivot block can rotate 90° “up” from either side of its vertical deployed position to its horizontal retracted position.
- 
- To place the lens in the field of view, the shaft should be adjusted to the position determined during the installation. If not, re-adjust the shaft until an image is obtained.

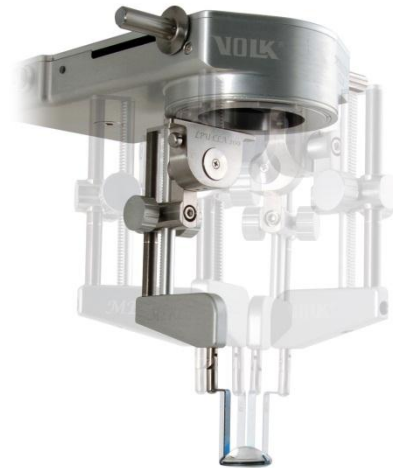

**Note – All MERLIN lenses have a hinge that allows the device to move up in the vertical plane to reduce the risk of injury to the patient:**

- If the lens is lowered onto the patient's eye
- If the patient moves up suddenly during a procedure



## Acquiring the Retinal Image – MERLIN CLA

- 1) Attach the MERLIN CLA, LPU and a non-contact lens and align the system using a model eye or target.
  - a) Recommendation: the Wide Angle lens is a good starting lens.
  - b) Move the LPU and lens to the horizontal “up” position after aligning the system.
- 2) Center the microscope in its automated movement range.
  - a) Most automated scopes have a centering function activated by a single button.
- 3) Achieve a focused corneal image with the microscope.
  - a) Again, for this step the LPU and lens should be in the horizontal “up” position
  - b) For a focused corneal image, the scope objective lens should be about 175mm or 200mm above the cornea, depending on its focal length design.
- 4) Position the LPU at the mid-point of its adjustment range.
- 5) Deploy the LPU to its vertical “down” position with the lens over the eye *and* move the CLA condenser lens to its forward position under the scope objective lens.
  - a) Move the CLA condenser lens using the sterilized handle.
- 6) Use the LPU focusing knob to achieve a focused image.
  - a) Do NOT use the scope pedals for this focusing step. You may wish to advise the physician to remove feet from the pedals to prevent the habitual re-focusing response.
  - b) You should see some retinal structures, though the field of view will be very small.
- 7) Now use the scope focusing pedal to move the scope head down so that the non-contact lens approaches the eye.
  - a) As the scope lowers toward the eye the image field of view will increase.
- 8) Using the scope focusing pedals does NOT change image focus when the non-contact lens is deployed. The scope focusing motion essentially becomes a “field of view” adjustment.
  - a) Optimal location of the non-contact lens is about 3-5mm above the eye.
- 9) This should provide the widest image field of view with a comfortable working distance of the lens above the eye.

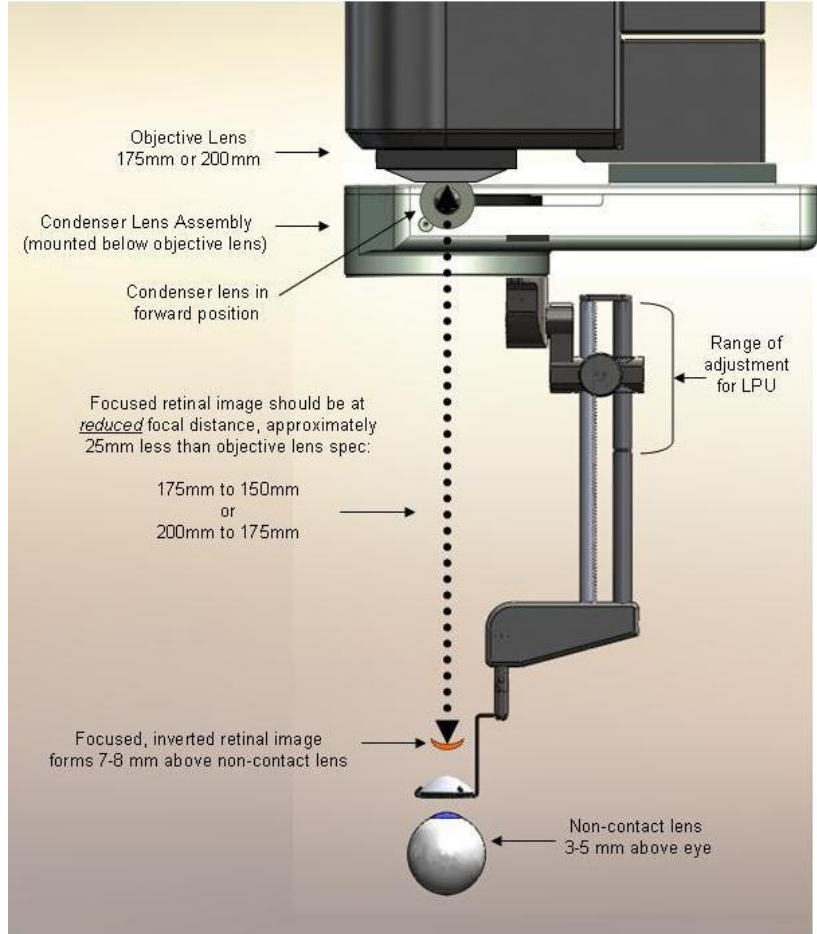

## Dismantling the MERLIN CLA

- Remove lens by grasping the hand-hold on the LPU shaft and by the lens above the hinge and pull apart until the lens is released.
- Follow with cleaning and sterilization as indicated in this manual.
- 
- To detach the LPU:
  - Press and hold the quick disconnect button on the LPU.
  - Pull the LPU from the mating holes in the rotating ring.
  - Release the quick disconnect button on the LPU.
  - Follow the instructions in the CLEANING AND STERILIZATION as indicated in this manual.
  -
- If desired, reverse the installation instructions to dismantle and remove the remaining components.
- The external surface of the MERLIN CLA housing and the condenser lens may be cleaned per the instructions in the CLEANING AND STERILIZATION section.
- The removable handle may be cleaned and sterilized as indicated by the instructions in this manual.



**NOTE: The MERLIN CLA is NOT designed for any type of sterilization. Exposure to any sterilization process may render the device non-usable and will void the warranty.**



## Cleaning and Sterilization

### Notes:

1. Disassemble instrument prior to cleaning and sterilization
2. Corrosive cleaning agents (e.g. chloride, saline, etc.) are not recommended. Enzymatic and cleaning agents with neutral pH are recommended.

**Reprocessing Limitations:** Repeated cleaning and sterilization has minimal effect on the arm assembly of the system when processed according to instructions. End of life is normally determined by wear and damage due to use.

### Preparation at the Point of Use

1. New, used or contaminated units must be cleaned.
2. **Body fluids and/or tissue should not be allowed to dry on the device prior to cleaning.** Remove excess body fluids and tissue.
3. Universal precautions for handling contaminated materials should be observed.
4. Instruments should be cleaned as soon as possible after use to minimize the drying of any body fluids and tissue.

**Preparation of cleaning agent:** Prepare a neutral pH enzyme and cleaning agent according to manufacturer's recommendations.

### ***MANUAL CLEANING INSTRUCTIONS FOR LENS POSITIONING UNIT, REMOVABLE HANDLE and LENSES (in sterilization tray as applicable)***

- 1) Use a lint free tissue dampened with an antibacterial, aldehyde-free solution to remove macroscopic visible deposits from each device. Pay special attention to any uneven surfaces, lumens, crevices, joints, corners and other hard-to-reach areas, e.g.:
  - a) Surfaces around the periphery of the lens, and the lens hinge;
  - b) The interior of the removable handle;
  - c) The geared rack and shaft of the Lens Positioning Unit (LPU), the LPU engagement mechanism, and screw heads and recesses in the LPU.
- 2) Prepare fresh Enzol solution (enzymatic cleaner - 1 ounce per gallon) using warm (30-43°C) sterile de-ionized water.
- 3) Disassemble devices (LPU should be separated from lens assembly, lens sterilization tray lid should be removed from tray).
- 4) Soak components in Enzol solution for 20 minutes. Actuate all movable parts while submersed in the cleaner. Use a syringe to "deliver" Enzol solution to hard-to-reach areas prior to soaking.
- 5) After soaking, aggressively brush devices with a soft-bristle brush until all traces of cleaner and soil are removed. Pay special attention to any uneven surfaces, lumens, crevices, joints, corners and other hard-to-reach areas, e.g.:
  - a) Surfaces around the periphery of the lens, and the lens hinge;
  - b) The interior of the removable handle;
  - c) The geared rack and shaft of the Lens Positioning Unit (LPU), the LPU engagement mechanism, and screw heads and recesses in the LPU.

NOTE: Do not brush glass lens to avoid damage but do brush the lens shaft, lens mounting ring and lens retention tines.

- 6) After brushing thoroughly rinse\* devices in a room temperature sterile de-ionized water bath (not under running water) until all visible cleaner has been removed. Actuate all movable parts while submersed in the rinse bath. Use a syringe to "deliver" rinse water to the hard-to-reach areas of each device. Repeat rinsing cycle 5 times, changing water between cycles.
- 7) Transfer the devices to a freshly prepared Enzol solution (per step 1 above) and sonicate for 20 minutes.
- 8) After sonication, thoroughly rinse\* devices in a room temperature sterile de-ionized water bath (not under running water) until all visible cleaner has been removed. Use a syringe to "deliver" rinse water to the hard-to-reach areas of each device. Repeat rinsing cycle 5 times, changing water between cycles.
- 9) Inspect each device for remaining debris. If any is observed, repeat the cleaning procedure with freshly prepared cleaning solutions until debris is removed.

\*The rinsing will be conducted under the water level to prevent aerosolization. Rinsing will be performed by:

- Agitating the device under water;
- Bringing the device above the water level;
- Re-immersing device under water.

#### **Inspection / Function Check**

- 1) Carefully check to ensure that all visible blood and soil has been removed.
- 2) Visually check for damage and/or wear.
- 3) Check the assembly and action of the moving joints to ensure operation throughout the range of motion. If damage or wear is apparent, contact Volk Optical or your distributor for return.

#### **Packaging**

- 1) Make sure the LPU and lens are disassembled.
- 2) Place lenses in the sterilization case provided. If applicable, use standard medical grade steam sterilization wrap following the double wrap method.

#### ***STERILIZATION INSTRUCTIONS FOR LENS POSITIONING UNIT, REMOVABLE HANDLE and LENSES (in sterilization tray as applicable)***

Steam sterilize using a pre-vacuum cycle for 5 minutes at a minimum temperature of 132°C.

#### ***CLEANING THE MERLIN CLA HOUSING AND CONDENSER LENS***

1. The external surfaces of the MERLIN CLA housing may be cleaned with a debris-free cloth dampened with any of the following: isopropyl alcohol (70%); sodium hypochlorite (0.5%); hydrogen peroxide (3%)
2. The condenser lens should be cleaned using Volk Precision Optical Lens Cleaner.

## Troubleshooting

### I do not see the desired image of the retina.

- Reset your LPU and scope adjustments:
  - Start with the LPU in the middle position of its adjustment range.
  - Deploy the LPU and non-contact lens under the objective lens so that the non-contact lens is about 1-2 cm above the eye.
  - Adjust the LPU fine focus knob to focus the retinal image.
    - The MERLIN CLA condenser lens effectively shortens the focal length of the microscope by ~25mm:
      - A 175mm objective lens functions as a ~150mm lens.
      - A 200mm objective lens functions as a ~175mm lens.
    - The focused retinal image actually forms about 7-8mm above the top surface of the lens. It is this point on which the scope objective lens focuses.
    - With the MERLIN CLA condenser lens and LPU deployed below the scope objective lens, the focused retinal image should be:
      - About 150mm (~ 6") below the objective lens for a 175mm lens.
      - About 175mm (~ 7") below the objective lens for a 200mm lens.
  - With a focused image, leave the LPU adjustment set. At this point in the focusing process, the retinal image will have a small field of view.
    - To widen the field of view of the retinal image, use the microscope focusing pedal to move the non-contact lens down to about 3-5mm above the eye (again, no further adjustment to the LPU).
- Other suggestions:
  - Make sure that the MERLIN lens is properly aligned to the optical axis of the microscope under the objective lens.
  - Make sure that the Objective Lens on the microscope is either 175mm or 200mm. Confirm that your LPU is designated with the same focal length number (175 or 200).
    - The MERLIN system Lens Positioning Units are designed use with specific objective lens focal lengths and are not interchangeable.
      - LPUs designed for 175mm objective lenses will not work with 200mm objective lenses, nor will 200mm LPUs work with 175mm objective lenses.

## Storage & Transport

- Retrieve all original shipping containers and packing materials. The shipping containers are customized to the components and should be used to prevent any damage that may occur during shipping.
  - If you do not have the original packaging, it can be ordered from Volk. (Refer to the components table on page 21)
  - The CLA **must** be shipped in packaging materials supplied by Volk, original or otherwise. **Failure to do so will void the warranty for the device.**



- Ensure the lenses are placed in the smaller sterilization case and shipping foam placed within to prevent any movement.
- Ensure the CLA and LPU are placed in the correct foam cut outs in the storage case.
- Place packing foam on top of all components and close the case.
- If shipping, it is recommended placing all cases within cardboard boxes to minimize any shipping damage.
- If keeping in storage, ensure the components are stored in the following conditions and stored in the cases provided:
  - Temperature: +10° C to +40°C

## Service and Repair

All components are to be inspected periodically for proper functionality. If any component or part is considered to be malfunctioning or defective, contact Volk Optical customer service (see contact details in this manual).

Repairs and corrective maintenance must only be carried out by Volk Optical Inc. Any work carried out by unauthorized persons will nullify any warranty.

### Inspection / Preventative Maintenance

The following steps should be done before each usage

Check the mating plate of the LPU for damage.

Components available for order from Volk:

Device	Platform	175 mm or 200 mm Objective Lens	Scope Make	PN
<b>Rotational Assembly</b>				11179
<b>Condenser Lens Assembly</b>	Manual	175		11377
	Manual	200		11378
<b>Lens Positioning Unit</b>	Rotational Assembly	175		11171
	Rotational Assembly	200		11172
	Condenser Lens Assembly	175		11173
	Condenser Lens Assembly	200		11174
<b>Lenses:</b>	Wide Angle			11183
	Small Diameter Wide Angle			11184
	Mid-Field			11182
<b>ROLS ∞</b>	Manual		Zeiss	11306
	Manual		Leica	11310
	Manual		Leica M520	11374
<b>Mounting Kits</b>	Rotational Assembly or Condenser Lens Assembly		See Appendix A	Call to order
<b>Storage Case</b>	MERLIN			11431
<b>Storage Case</b>	ROLS ∞			11432

**Product Warranty:**

The Seller warrants to the Purchaser that the goods furnished hereunder will, for the appropriate periods of product warranties, as defined on our user instructions shipped with each product, conform to Sellers' agreed to specifications. The obligation of the Seller, and the Purchaser's sole and exclusive remedy hereunder, shall be limited, at the Seller's option, to replacement of defective goods or refund of the purchase price thereof. Purchaser shall not return goods unless authorized in writing by Seller. Seller shall have the right to inspect the goods at Purchaser's installation. Purchaser's failure to give prompt written notice (30 days) upon discovery of any alleged defect shall constitute a waiver by Purchaser of all claims with respect thereto. Notwithstanding the foregoing warranties and remedies, seller shall have no obligation hereunder if the goods become defective as a result of improper storage, contamination, adulteration, improper use or misapplication after delivery thereof to Purchaser. If the product fails to function due to defects in either materials or workmanship, Volk will, at its option, either repair or replace the product without charge, subject to the Warranty Limitations.

Volk Optical warrants its MERLIN Surgical System against defects in material or workmanship for a period of 1 year from receipt by end-user.

Volk Optical warrants its Volk Vitrectomy Lenses against defects in materials or workmanship for a period of 1 year from receipt by end-user.

Volk Optical warrants its Volk Autoclave Sterilizable (ACS) Vitrectomy Lenses against defects in materials or workmanship for the lesser of 6 months from receipt by end-user or 100 sterilization cycles.

Customers shall be responsible for returning products for warranty service to Volk Optical, 7893 Enterprise Drive, Mentor, Ohio 44060 - USA.

Warranty repairs will include all labor, adjustments and replacement parts. Replacement parts may be remanufactured or contain remanufactured materials.

Warranty service may not be provided without proof the product was purchased from Volk Optical Inc. or an Authorized Volk Distributor.

This Warranty becomes null and void if the customer fails to return the product in packaging that is consistent with the original protective packaging and it results in shipping damage.

This Warranty becomes null and void if the customer fails to follow the recommended cleaning, disinfection and sterilization instructions and/or cautions contained in the product instruction manual.

This Warranty does not cover service required because of disassembly, unauthorized modifications or service, misuse or abuse.

**SELLER MAKES NO OTHER WARRANTY, EXPRESS OR IMPLIED, OF THE PRODUCT SUPPLIED HEREUNDER, INCLUDING, WITHOUT LIMITATION, IMPLIED WARRANTIES OF MERCHANTABILITY AND FITNESS FOR A PARTICULAR PURPOSE AND ALL SUCH WARRANTIES ARE HEREBY EXPRESSLY EXCLUDED. SELLER SHALL HAVE NO LIABILITY FOR LOSS OF PROFITS, OR SPECIAL, INCIDENTAL, OR CONSEQUENTIAL DAMAGES UNDER ANY CIRCUMSTANCES OR LEGAL THEORY, WHETHER BASED ON NEGLIGENCE, BREACH OF WARRANTY, STRICT LIABILITY, TORT, CONTRACT, OR OTHERWISE. SELLER SHALL IN NO EVENT BE LIABLE IN RESPECT OF THIS ORDER AND/OR PRODUCT DELIVERED ON ACCOUNT OF THIS ORDER FOR ANY AMOUNT GREATER THAN THAT PAID TO SELLER ON ACCOUNT OF THIS ORDER. THE PURCHASER ACKNOWLEDGES THAT IT IS PURCHASING THE GOODS SOLELY ON THE BASIS OF THE COMMITMENTS OF THE SELLER EXPRESSLY SET FORTH HEREIN.**

## Ordering Information:

Orders may be placed with the Authorized Volk Distributor in your region. Authorized Distributor contact information is available directly from Volk.

Volk Optical Inc.  
7893 Enterprise Drive  
Mentor, Ohio 44060  
USA

Toll free within the United States:  
1-800-345-8655  
Phone: 440 942 6161  
Fax: 440 942 2257  
Email: [volk@volk.com](mailto:volk@volk.com)  
Website: [www.volk.com](http://www.volk.com)

## Regulatory Information



### EU REPRESENTATIVE

The Volk authorized representative based in the European Union (EU) is:

Altomed Limited  
2 Witney Way  
Baldon Business Park  
Tyne and Wear  
NE35 9PE England  
Tel: +44(0) 191 519 0111

Note: This product complies with current required standards for electromagnetic interferences and should not present problems to other equipment or be affected by other devices. As a precaution, avoid using this device in close proximity to other equipment.

Members of the European Union should contact their authorized Volk Distributor for disposal of this unit.







Certificate  
FM 71461



## Appendix A – Microscopes and Adapters

*Note: Please check your microscope model for the correct style needed before ordering. Contact your authorized distributor to order other styles than shown below.*

Volk Optical Kit Part Number (plate and screws)	Microscope Make & Model	Adapter Plate Style
11408	Zeiss	
11409	Leica / Wild	
11410	Moller-Wedel (also ships with #6-32 screws)	
11412	Takagi	
11413	Topcon	

Volk Optical Kit Part Number (plate and screws)	Microscope Make & Model	Adapter Plate Style
11481	Leica 690 for MERLIN CLA	
11425	Spacer Kit	
11553	Zeiss MD for MERLIN CLA	



**Volk Optical Inc.**

7893 Enterprise Drive  
Mentor, Ohio 44060  
USA

Phone: 440 942 6161

Toll free within the United States: 1-800-345-8655

Fax: 440 942 2257

Email: [volk@volk.com](mailto:volk@volk.com)

Website: [www.volk.com](http://www.volk.com)

MERLIN Surgical is patent pending

Copyright © 2010 Volk Optical Inc.

Part No. IM-039  
Revision: A  
Effective: 12.14.10